

AOC removal and accumulation of bacteria in experimental sand filters

Elimination du COA et accumulation de matières bactériennes dans les filtres à sable expérimentaux

W.A.M. HIJNEN¹, D. VAN DER KOOIJ¹

Reçu le 12 novembre 1991, accepté pour publication le 23 juin 1992*.

SUMMARY

Using small sand filters under well defined laboratory conditions, filtration experiments were performed with tap water supplemented with acetate. The objective of these experiments was to determine the effect of different acetate concentrations on (i) the removal of easily assimilable organic carbon (AOC) in the filter (ii), the clogging of the filter and (iii) the bacteriological quality of the filtrate.

The results of the experiments revealed that the reduction capacity of biological filtration processes for acetate is relatively high. Acetate removal resulted in an increased microbiological activity in the top layer (< 1cm) of the filter bed and accumulation of bacterial matter was observed at an influent AOC concentration as low as 0.005 mg of ac-C eq/l. Clogging of the filter bed occurred at an influent acetate concentration of 0.01 mg C/l. Based on these observations it was concluded that the AOC concentration of water used for infiltration in recharge wells should be less than 0.01 mg ac-C eq/l. This level is similar to the level advised for biologically-stable drinking water.

A linear relationship was found between the acetate removal in the experimental filters and the colony count in the filtrate. It was recommended that the AOC load in the final filtration process in water treatment therefore should be limited to prevent high colony counts in the filtrate, thus leading to the use of post disinfection.

Key-words : sand filters, easily-assimilable carbon (AOC), AOC removal, microbiological activity, biological clogging, colony counts.

1. The Netherlands Waterworks' Testing and Research Institute, KIWA Ltd. P.O. Box 1072, 3430 BB Nieuwegein, The Netherlands.

* Les commentaires seront reçus jusqu'au 30 juin 1993.

RÉSUMÉ

Ces dix dernières années, les méthodes permettant de déterminer la concentration des composés organiques assimilables par les bactéries dans de l'eau potable ont suscité de plus en plus d'intérêt envers les possibilités de prévision et de contrôle de la croissance des bactéries pendant le stockage et la distribution. La détermination dite "COA" (carbone organique aisément assimilable) introduite par VAN DER KOOIJ *et al.* (1982) a été développée et appliquée dans le but de surveiller les concentrations de COA pendant le traitement, le stockage et la distribution. Sur la base des résultats, il a été établi un critère pour de l'eau potable biologiquement stable (VAN DER KOOIJ et HIJNEN, 1990). Ce critère exerce une influence sur la conception du traitement de l'eau. Ceci étant, il convient de porter davantage d'attention à l'effet des processus de traitement – et plus particulièrement des processus de filtration – sur la concentration de COA.

Des expériences de filtration ont été effectuées sur de petits filtres à sable, dans des conditions de laboratoire bien déterminées. L'objectif de ces expériences consistait à déterminer (I) l'élimination du carbone organique aisément assimilable (COA) dans le filtre, pour des concentrations d'eaux affluentes différentes, (II) l'effet produit sur l'engorgement du filtre et (III) la qualité bactériologique du filtrat.

De l'acétate a été ajouté à l'eau d'entrée des filtres en tant que modèle de substrat, dans une gamme de concentrations allant de 0,01 à 1 mg/l C. L'eau fournie était de l'eau potable préfiltrée à faible teneur en COA (0,005 mg ac-C eq/l). Au cours du temps de fonctionnement, la concentration de COA ainsi que le nombre de colonies dénombrées dans l'eau ont été contrôlés, de même que la perte de charge de la couche filtrante. A l'expiration du temps de fonctionnement, la concentration de matière bactérienne a été déterminée dans le sable des filtres.

Dans les filtres à sable dont le temps de contact du lit vide était de 10 minutes, les concentrations d'acétate (S_{ac}) inférieures ou égales à 0,25 mg/l C ont été totalement éliminées. La réduction de COA pour les valeurs S_{ac} de 0,5 et de 1,0 mg/l C atteignait 90 %. Il en a été conclu que les processus de filtration biologique peuvent fort bien être appliqués pour l'élimination de composés organiques aisément assimilables, tels l'acétate et l'éthanol qui sont fréquemment utilisés dans les processus d'élimination biologique des nitrates au cours du traitement de l'eau potable.

La capacité d'élimination de l'acétate, offerte par les filtres à sable expérimentaux, était élevée par comparaison avec la réduction de COA observée dans le cas des filtres à sable utilisés pour la production d'eau potable à partir d'une eau de surface (VAN DER KOOIJ, 1984). La teneur en COA du filtrat dépassait le critère applicable à l'eau potable biologiquement stable, c'est-à-dire 0,01 mg ac-C eq/l, pour des charges volumique d'acétate (LV_{ac}), relevées sur les filtres à sable expérimentaux, supérieures à 1600 mg ac-C/(m³.h). La charge volumique critique en COA des filtres à sable, utilisés dans les installations de traitement citées plus haut, au-dessus de laquelle la teneur en COA du filtrat dépasse de critère, est estimée à environ 100 mg COA-C/(m³.h).

Ces résultats indiquent que l'acétate est éliminé plus rapidement qu'une quantité équivalente de composés mesurée par détermination du COA.

Par suite de la consommation d'acétate, le nombre de bactéries présentes dans le lit filtrant s'est accru. On a constaté qu'un net rapport linéaire existait entre la concentration d'acétate, d'une part, et le nombre de colonies dénombrées (par boîte) sur le sable à la surface du filtre, d'autre part. L'accumulation de bactéries a été observée, même pour une concentration de COA de 0,005 mg ac-C/l, tandis que l'engorgement des filtres se produisait sous une

concentration d'acétate de 0,01 mg ac-C/l. Des concentrations accrues de carbone organique ont été mesurées sur le sable, dans les premiers millimètres d'épaisseur du lit filtrant. Les résultats obtenus à la suite d'études sur le terrain, relatives à l'infiltration d'eau dans les puits de recharge, ont montré que, pour des valeurs de COA inférieures à 0,01 mg ac-C eq/l, la durée de processus n'atteignait pas un an, du fait de l'engorgement observé dans le sous-sol. Par conséquent, la concentration de carbone organique assimilable (COA) dans l'eau utilisée pour l'infiltration doit être inférieure à 0,01 mg ac-C eq/l afin d'éviter l'engorgement biologique. Un niveau de COA similaire a été conseillé pour l'eau potable biologiquement stable (VAN DER KOOIJ and HIJNEN, 1990).

La consommation d'acétate dans les filtres a eu comme autre conséquence l'accroissement du nombre de colonies hétérotrophes dénombrées dans l'eau, selon un rapport linéaire avec la concentration d'acétate dans l'eau affluente. Le nombre de colonies dénombrées présentes dans le filtrat s'est accru pour atteindre une valeur moyenne de 10^4 cfu/ml, sous une concentration d'acétate de 0,068 mg ac-C/l (charge volumique d'acétate de 400 mg ac-C/(m³.h)). Au vu de ces résultats, il a été conclu que la charge volumique en COA d'une filtration finale dans une installation de traitement des eaux devrait être limitée, entre autre afin d'éviter le recours à une post-désinfection visant à réduire le nombre de germes hétérotrophes.

Mots clés : filtres à sable, carbone organique aisément assimilable (COA), réduction de COA, activité microbiologique, l'engorgement biologique, nombre de colonies dénombrées.

1 - INTRODUCTION

In the past decade, interest in methods for determining the concentration of organic compounds available for bacteria in drinking water has steadily increased in order to predict and control the regrowth of bacteria during storage and distribution. To date, several methods are available for this purpose (VAN DER KOOIJ *et al.*, 1982 ; WERNER, 1985 ; JORET and LEVI, 1986 ; SERVAIS *et al.*, 1987 ; STANFIELD and JAGO, 1988). The so-called AOC determination, introduced by VAN DER KOOIJ *et al.* (1982) has been developed and applied to monitor AOC concentrations during treatment, storage and distribution. Based on the results VAN DER KOOIJ and HIJNEN (1990) have defined a criterium for biologically-stable drinking water. This criterium affects the design of water treatment. Consequently, more attention is needed for the effect of treatment processes on the AOC concentration.

Increases of the AOC content in water during treatment processes have been observed after ozonation (VAN DER KOOIJ *et al.*, 1987) and biological nitrate removal (HIJNEN *et al.*, 1988), processes of growing importance in the near future. As a result, interest in biological filtration and artificial recharge, processes which are especially suited to remove AOC and bacteria from the water (e.g., VAN DER KOOIJ, 1984 ; SERVAIS *et al.*, 1991 ; HIJNEN *et al.*, 1988), is also increasing. AOC removal will result in accumulation of bacteria in filter

beds. This accumulation may affect the hydraulic properties of the filter bed as well as the quality of the filtrate (high colony counts). Filtration experiments with acetate as a model substrate were performed in the laboratory under well defined conditions. The objective of these experiments was to quantify the effects of the acetate concentration on (i) AOC removal of the filters, (ii) the accumulation of bacterial matter in the filter bed and (iii) the number of bacteria in the filtrate.

2 - MATERIALS AND METHODS

2.1 Experimental apparatus

An experimental filtration system, as developed by SCHIPPERS and VERDOUW (1984) for measuring the filtration-index of infiltration water, was adapted to perform filtration experiments with dosage of acetate. This system consisted of 4 columns containing sand (*fig. 1*). The technical and hydraulic characteristics are specified in table 1. During the operation period the flow rate was kept constant by a flow control after the filters, independently of the head loss. The system was operated at 1 ATO to avoid clogging caused by degassing of the water. To prevent the growth of photo-lithotrophic organisms, the filters were operated in the dark. The columns contained 1.2 litre of sand on top of a support of 1.5 litre of fine gravel. Prefiltered (1 μm candle filter) drinking water prepared from anaerobic ground water was used in the filtration experiments (*table 2*). The prefilter was renewed every two months.

Cleaning of the water supply at position 5 (*fig. 1*) was done every two or three weeks without affecting the constant head pressure above the filter beds. Sudden pressure drops would disturb the sand surface.

Table 1 Technical characteristics of the experimental filtration system.

Tableau 1 Caractéristiques techniques du système de filtration expérimental.

Diameter (cm)	9
Surface (cm ²)	63.6
Length of filter (cm)	20.0
Diameter of the sand (mm)	0.42-0.6
Length of support (cm)	21.5
Diameter of support sand (mm)	2.0-3.0
Feed Flow rate (l/h)	8.0
Flow rate (m ³ /m ² .h)	1.2
Empty bed contact time (min)	10.0

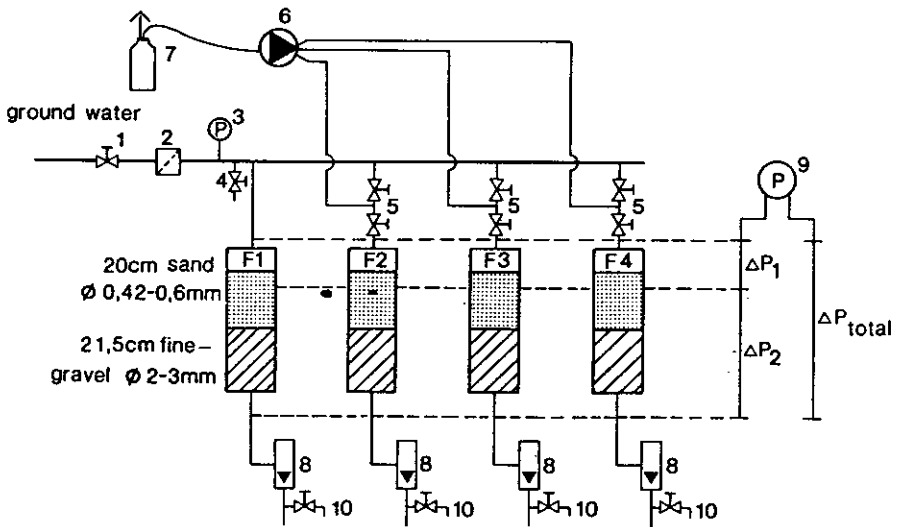

- 1 reducing valve
- 2 candle filter (1 μm)
- 3 manometer (100 kPa)
- 4 sampling point
- 5 dosage point
- 6 peristaltic feed pump
- 7 supply-vessel (3 litre) with sterile solution of acetate and sterile air supply
- 8 flowcontrol
- 9 ΔP-control (mbar)
- 10 sampling point

Figure 1 The experimental filtration system for studying biological filtration processes.

Système de filtration expérimental destiné à l'étude des processus de filtration biologique.

Table 2 Characteristics of the filtration water.

Tableau 2 Caractéristiques de l'eau de filtration.

Parameter	Values
NH ₄ ⁺ (mg/l)	< 0.01
NO ₃ ⁻ (mg/l)	0.4
PO ₄ ³⁻ (mg/l)	< 0.02
Fe (mg/l)	0.134
TOC (mg C/l)	1.8
UVE 254 nm (m ⁻¹)	5.98
AOC (mg ac-C eq/l)	0.005*
AOC/TOC (%)	0.25
Temperature (°C)	10.0-18.0

* Median value (number of samples = 10 ; minimum and maximum resp. 1 and 13 μg ac-C eq/l).

2.2 Acetate-dosage procedure

The water was supplemented with acetate, which is easily biodegradable. The acetate concentrations (S_{ac}) were 1.0, 0.5, 0.25, 0.15, 0.1, 0.075, 0.040, 0.025, 0.01 and 0.0 mg C/l (control filter), respectively. From a sterile supply vessel, containing a 3 liter solution of concentrated sodium acetate at the desired concentration and sodium chloride (4.3 g/l), the substrate was dosed into the influent of the filters by a peristaltic pump (Gilson Minipuls 2) at a flow rate of ca. 0.4 ml/min. The vessel had a sterile air supply (Millex-GS 0.22 μ m). Mixing was achieved by the application of a restriction (2 mm) after the dosage point. The dosage of acetate was checked daily by measuring the rise of the conductivity of the water (43 μ S/cm²) after the filters as caused by the addition of 25 mg NaCl/l to the influent of the filters. Calculations, based on these measurements revealed that the acetate concentration actually added to the water deviated less than 10 % from the concentrations mentioned above. The Acetate volume load (LV_{ac} : mg of C/(m³.h)) of the sand filters was calculated from the empty bed contact time (10 min.) and the acetate concentration (S_{ac} : mg of C/l).

2.3 Water quality monitoring

The concentration of easily Assimilable Organic Carbon (AOC) of the ground water before acetate dosage (influent) and after the experimental filters (Filtrate) was determined several times by the method described in a previous paper (VAN DER KOOIJ and HIJNEN, 1990). The density of heterotrophic bacteria in the influent and effluent of the filters was measured with the colony count on Diluted-Broth Agar (DBA) medium, containing 5/8 g of Lab-Lemco broth (Oxoid Ltd.), 3/8 g of meat extract and 12 g of agar per liter of demineralized water. Plates of this medium were inoculated (in triplicate) using the spread-plate technique and the colony forming units (cfu) on the plates were counted after 10 days of incubation at 25 °C.

2.4 Bacterial matter in the filter bed

The head loss over the total filter bed (P_{tot}) was monitored daily in mbar. The head loss over the first cm (P_1) was measured at the end of the operational period. The head loss was calculated as kPa at 10 °C (1 mBar = 0.1 kPa at 10 °C). The final head loss of the filter was restricted to the maximum of the dP-meter being 250 mBar (25 kPa at 10 °C).

After the final head loss was reached, the number of bacteria on the sand in the filters was measured. For this purpose 2 à 4 gram of the sand was suspended in 100 ml sterile tap water, treated in an ultrasonic cleaning bath for 3 minutes, and the colony count on DBA of the suspension was determined. The first ultrasonic treatment yielded > 90 % of the total colony count obtained after three repeated treatments of the sand sample using fresh sterile tap water (unpublished results). Furthermore, the concentration of organic carbon in the sand was measured as previously described (HIJNEN *et al.*, 1988). The colony count of the sand and the organic carbon content were expressed as cfu per ml of sand and ml of carbon per ml sand, respectively, using the dry-volume density of the sand (1,6 g/ml).

3 - RESULTS

3.1 Acetate reduction by the sand filters

During the operation time of the experimental filters the acetate removal was estimated by the AOC determination. The AOC-content of the supplied ground water was about 0.005 mg of ac-C eq/l (table 2) and the observed AOC/DOC ratio was in the same order of magnitude as reported by VAN DER KOOIJ and HIJNEN (1990) for ground water. The control filter (no acetate added) caused an increase of the AOC concentration in the water of 0.0003 – 0.0022 mg of ac-C eq/l in the first 50 days of operation (fig. 2a). This increase might have been the result of extraction of easily assimilable compounds from the sand. After an operation time of 136 and 174 days the AOC concentration

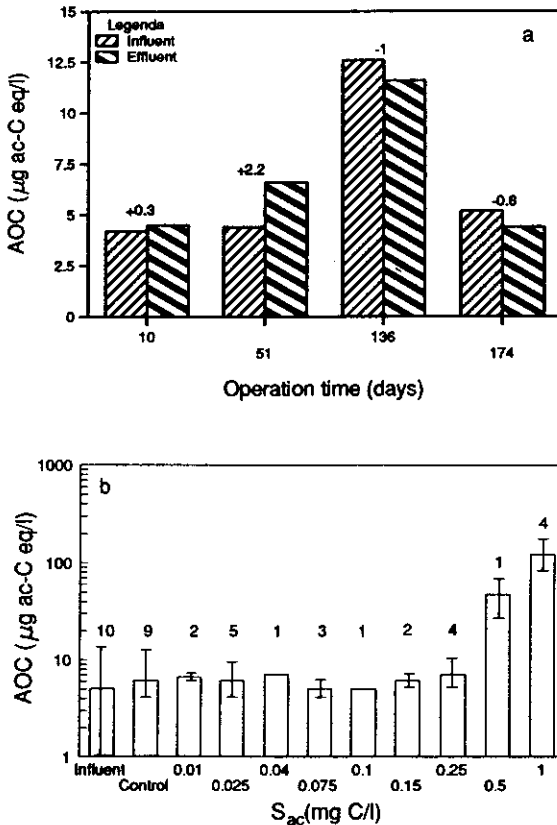

Figure 2 (a) AOC removal of the control filter measured during the operation time and (b) the average AOC concentration in the effluent of the filters with increasing acetate concentration (number of observations above the bars).

(a) *Elimination du COA par le filtre-témoin, mesurée pendant le temps de fonctionnement et (b) concentration moyenne de COA dans l'eau de sortie des filtres, pour des concentrations d'acétate croissantes (le nombre d'observations est indiqué au-dessus des barres).*

was reduced with 1 and 0.8 μg of C/l, respectively. At acetate concentrations of 0.25 mg of C/l or less, the AOC concentration of the filtrate was < 0.01 mg ac-C eq/l and in the same order of magnitude as measured after the control filter (fig. 2b). In the effluent of the filters supplied with water containing 1 and 0.5 mg acetate-C/l the AOC concentration was clearly above 0.01 mg ac-C eq/l. These data reveal that the acetate removal was complete up to an acetate concentration of 0.25 mg acetate-C/l (volume load (LV_{ac}) of 1500 mg of acetate-C/($\text{m}^3\cdot\text{h}$)).

The AOC concentration in the filtrate exceeded the AOC criterium for biologically stable drinking water (10 μg ac-C eq/l) at an estimated LV_{ac} value of 1600 mg C/($\text{m}^3\cdot\text{h}$) (fig. 3). The removal efficiency at LV_{ac} of 3 000 and 6 000 mg of ac-C/($\text{m}^3\cdot\text{h}$) was estimated at 90 %.

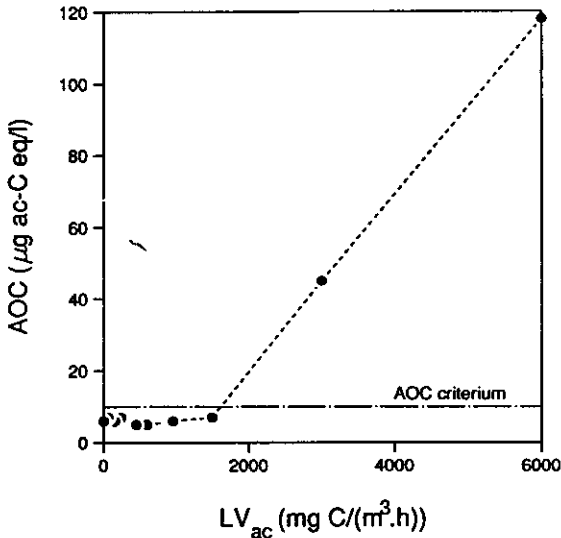

Figure 3 The AOC concentration in the filtrate of the filters as a function of the acetate volume load (LV_{ac}).

Concentration de COA dans le filtrat des filtres en fonction de la charge de volume d'acétate (LV_{ac}).

In an experiment with an S_{ac} value of 0.025 mg of ac-C/l, the influence of the empty bed contact time on the acetate removal was determined. At empty bed contact times between 60 and 2.4 minutes respectively, the AOC concentration in the filtrate hardly differed and was of the same level as the average AOC value in the filtrate of the control filter (table 3).

Table 3 The AOC concentration in the filtrate of the filters supplemented with 0.025 mg ac-C/l at different filtration velocities (average AOC value after control filter was 0.006 mg ac-C eq/l ; number of samples 12).

Tableau 3 Concentration de COA dans le filtrat des filtres dopés à 0,025 mg ac-C/l et à des vitesses de filtration différentes (la valeur moyenne de COA après le filtre-témoins était de 0,006 mg ac-C eq/l ; nombre d'échantillons : 12).

Filtration rate (m/h)	Empty bed contact time (min.)	LVac (mg ac-C/(m ³ .h))	AOC effluent (mg ac-C eq/l)
0.2	60	25	0.006
1.0	12	125	0.007
2.0	6	250	0.007
5.0	2.4	625	0.007

3.2 Acetate reduction and bacteria in the filter bed

The colony count of the sand in the control filter showed a slight and systematic decrease as a function of the filter bed depth (*fig. 4a*). When the influent of the filters was enriched with acetate, the profile of the colony count as a function of the filter bed clearly exceeded those deeper in the filters. The microbiological activity was high in the top layer of the filters and influenced the concentration of bacteria deeper in the filter bed. Furthermore, a linear relationship was observed between the colony count of the sand at the filter bed surface and the acetate concentration S_{ac} in the influent of the filter (*fig. 4b*).

3.3 Accumulation of bacterial matter in the filter bed

The colony count of the sand in the control filter increased with increasing operation time (*fig. 5a*). This phenomenon was also observed in the filter with an S_{ac} of 0.1 mg ac-C/l. These results show that even in the control filter a steady state was not achieved, indicating that an accumulation of bacterial matter in the filter bed occurred. At an AOC concentration of 0.005 mg ac-C eq/l the head loss over the filter bed was raised only 1 kPa within an operational period of 200 days (*fig. 5b*). At an S_{ac} of 0.01 mg ac-C/l however, accumulation of bacterial matter caused an increase of the head loss of about 23 kPa after 200 days. The head loss (dp_{tot}) of the filter bed was caused for more than 90 % by the top layer of 1 cm. In this part of the filter bed of the filters supplied with acetate as well as the control filter an increase of the concentration of organic carbon was observed (*fig. 6*).

3.4 Bacteria in the water

The control filter reduced the heterotrophic colony count as determined on DBA medium (*fig. 7a*). When acetate was added, the colony count of the filtrates was higher than the colony count determined in the filtrate of the control filter. Figure 7b shows a linear relationship between the log values of

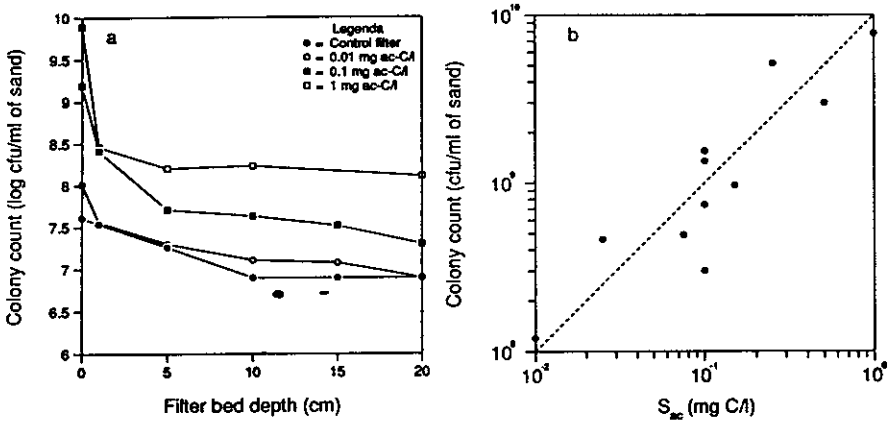

Figure 4 (a) Heterotrophic colony counts on DBA medium of the sand sampled at various filter bed depths from the control filter and the experimental filters supplied with an acetate concentration of 0.1 and 0.01 mg C/l and (b) the heterotrophic colony count on DBA medium on the sand from the filter surface of the experimental filters as a function of the acetate concentration in the influent.

(a) Nombre de colonies hétérotrophes dénombrées avec le milieu DBA (diluted broth agar) sur le sable prélevé à différentes profondeurs de couches filtrantes, sur le filtre-témoin et sur les filtres expérimentaux dotés d'une concentration d'acétate de 0,1 et 0,01 mg C/l et (b) nombre de colonies hétérotrophes dénombrées avec le milieu DBA à la surface des filtres expérimentaux, en fonction de la concentration d'acétate dans l'eau affluente.

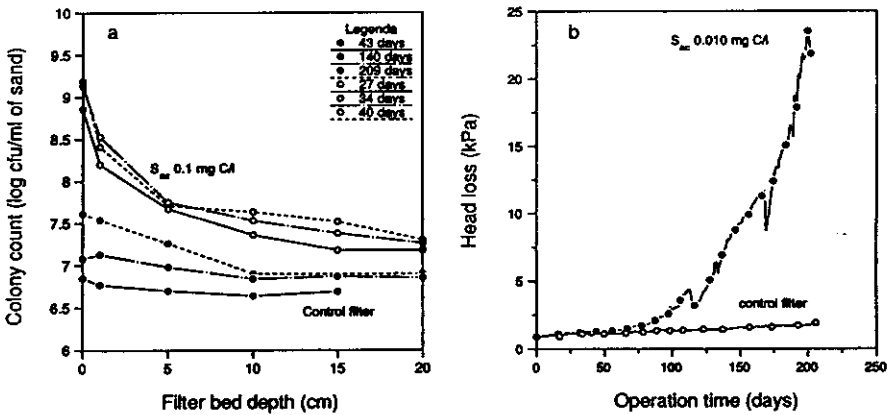

Figure 5 (a) Colony count on DBA medium of the sand of the control filter and the experimental filter supplied with an acetate concentration of 0.1 mg C/l after different times of operation and (b) the head loss of the control filter and the filter supplied with an acetate concentration of 0.010 mg of ac-C/l as a function of the operation time.

(a) Nombre de colonies hétérotrophes dénombrées avec le milieu DBA sur le sable du filtre-témoin et du filtre expérimental doté d'une concentration d'acétate de 0,1 mg C/l après des temps de fonctionnement variés et (b) perte de charge du filtre-témoin et du filtre expérimental doté d'une concentration d'acétate de 0,01 mg C/l, en fonction du temps de fonctionnement.

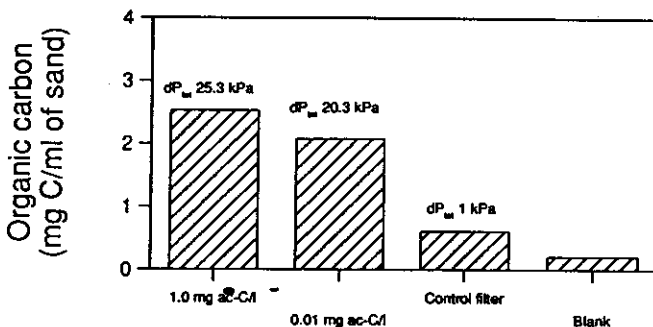

Figure 6 Concentration of organic carbon in the sand of the filter bed surface of the several experimental filters after the operation time and in the blank (untreated sand).

Concentration en carbone organique dans le sable à la surface de lit filtrant, mesurée sur les divers filtres expérimentaux après le temps de fonctionnement ainsi que dans le sable non traité (témoin).

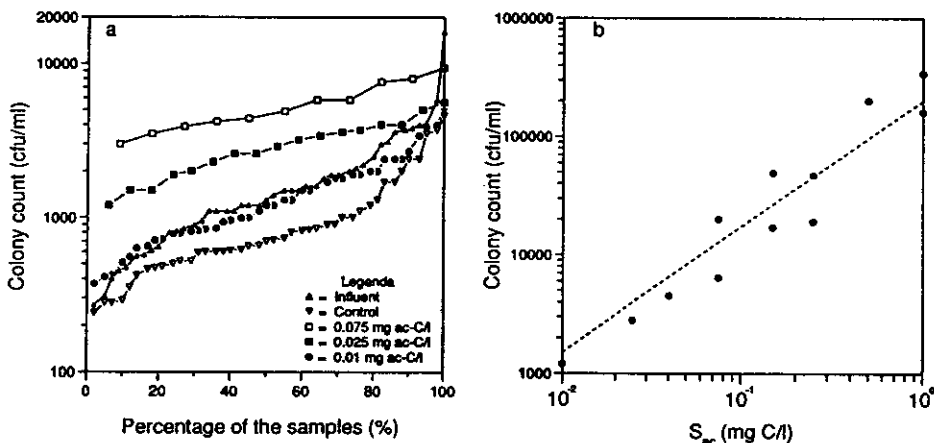

Figure 7 (a) The cumulative frequency distribution of the heterotrophic colony count on DBA medium of the influent and the filtrate of the sand filters at different acetate concentration and (b) the heterotrophic colony count on DBA medium of the filtrate of the sand filters as a function of the acetate concentration in the influent.

Fréquence relative cumulée du nombre de colonies hétérotrophes dénombrée avec le milieu DBA sur l'eau affluente et le filtrat des filtres à sable, pour différentes concentrations d'acétate et (b) nombre de colonies hétérotrophes dénombrée avec le milieu DBA du filtrat des filtres à sable, en fonction de la concentration d'acétate dans l'eau affluente.

the colony count of the effluent of the filters and the log values of the acetate concentration. The relationship is given by :

$$\log [\text{CFU/ml of sand}] = 1.19 (\text{SD } 0.11) \log [S_{ac}] - 1.82 (\text{SD } 0.25)$$

(number of data 12 ; r = 0.96)

From this equation it can be calculated that the median value of the colony count in the water was raised above 10^4 cfu/ml at an acetate concentration of 0.068 mg C/l i.e. an LV_{ac} value of 400 mg of ac-C/($m^3.h$).

4 - DISCUSSION

4.1 AOC removal by biological filtration

The results of the filtration experiments revealed that biological filters have high removal capacities for easily assimilable organic compounds like acetate from water. Hence biological filtration processes are very suitable to remove such compounds (e.g. ethanol) as used for biological nitrate reduction (e.g. PHILIPOT, 1982 ; RICHARD and LEPRINCE, 1984 ; BÖCKLE *et al.*, 1984 ; ROENNEFAHRT, 1986).

In a study performed at several water treatment facilities in the Netherlands the maximum observed AOC volume load (LV_{AOC}) of the investigated sand filters was 0.854 g of ac-C eq/($m^3.h$) (VAN DER KOOIJ, 1984). The AOC reduction capacity of these filters was less than the acetate reduction capacity of the experimental filters in this study (*fig. 8*). The AOC content of the filtrate was below the AOC criterium of biologically stable drinking water at LV_{AOC} values below 100 mg of AOC-C/($m^3.h$). Hence, acetate appeared to be more rapidly removed by sand filtration than an equivalent amount of natural assimilable organic carbon compounds as measured with the AOC determination. This observation suggests that the major part of the AOC concentration is less easily biodegradable than acetate. Moreover, the apparent natural acetate concentration in water is usually only a minor fraction of the AOC concentration (VAN DER KOOIJ, 1984). This apparent acetate concentration was calculated from the growth rate (μ ; h^{-1}) of the AOC test strain *Pseudomonas fluorescens* as observed in the AOC growth curves and the growth kinetic of this organism for acetate.

4.2 Threshold AOC content for removal by filtration processes

The data on AOC concentration in the water obtained from the control filter in the laboratory experiments revealed that the AOC removal was small (< 20 %) at an AOC concentration of 0.005 mg ac-C eq/l. These results confirm the earlier observations of limited (< 50 %) AOC removal at AOC concentrations in the influent below 0.01 mg ac-C eq/l (VAN DER KOOIJ, 1984). At AOC levels below 10 μ g ac-C eq/l, the AOC content is hardly decreased by biological filtration processes, thus suggesting a high biological stability of the organic matter in the water. These observations support the AOC criterium for the biological stability of drinking water as based on the AOC removal in drinking water during distribution (VAN DER KOOIJ and HIJNEN, 1990).

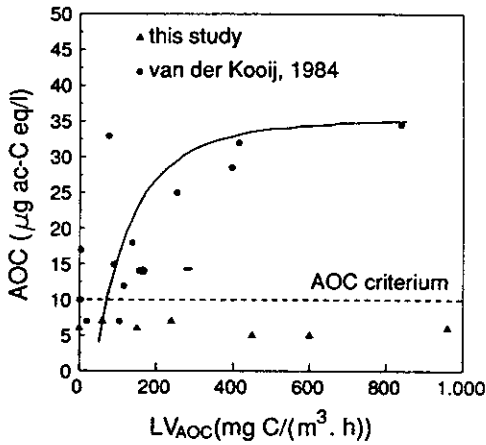

Figure 8 The AOC concentration in the filtrate of biological filters from different water treatment plants in the Netherlands as a function of the AOC volume load (LV_{AOC}).

Concentration de COA dans le filtrat des filtres biologiques équipant diverses installations de traitement des eaux, aux Pays-Bas, en fonction de la charge volumique en COA (LV_{COA}).

4.3 Accumulation of bacterial matter

The filtration experiments revealed that the heterotrophic colony count on the sand of the filters was linearly related with the acetate concentration in the influent. High microbiological activity in the top layer of the experimental filters causing accumulation of bacterial matter and clogging of the filter bed have also been observed by other investigators (GUPTA and SWARTZENDRUBER, 1962 ; SHAW *et al.* 1985 ; KAWANISHI *et al.*, 1990). This study revealed that these phenomena occurred even at an acetate concentration as low as 0.01 mg C/l.

In the Netherlands, clogging problems have been observed with experimental recharge wells for infiltration of pretreated surface water (PETERS, 1985). A study published before (HIJNEN and VAN DER KOOIJ, 1992) revealed an empirical model for the relationship between the acetate concentration and the clogging period of the sand filters. The model was not suitable for the prediction of the clogging period of a recharge well based on the measured AOC concentration. One of the reasons was that the compounds measured in the AOC determination were less easily assimilable than acetate (§ 4.1). Nevertheless it was observed that clogging was limited at an AOC concentration of less than 0.01 mg ac-C eq/l, but at an AOC concentration of 0.06 mg ac-C eq/l a rapid and severe clogging of the recharge well was observed. Based on these results and the data obtained in this study, an AOC concentration below 0.01 mg ac-C eq/l was advised for water used for artificial infiltration with recharge wells to prevent clogging problems. This criterium defined by AOC measurements for the suitability of water for infiltration is similar to the AOC criterium as defined for the biological stability of drinking water (VAN DER KOOIJ and HIJNEN, 1990).

4.4 Bacteria in the filtrates

As a result of the acetate removal in the experimental filters the number of bacteria in the filtrate increased linearly with the acetate concentration in the influent. These observations reveal that a high volume load of the final filter of a water treatment plant results in high concentrations of bacteria in the drinking water. Production of drinking water with a low heterotrophic colony count therefore requires the application of a post disinfection or the use of a final filtration step with a low volume load of AOC.

5 - CONCLUSIONS

The following conclusions can be drawn from the presented results :

- The removal capacity of biological filtration processes for easily assimilable organic carbon compounds like acetate from water is relatively high. Within an empty bed contact time of 10 minutes the removal of a concentration of 1.0 mg acetate-C/l was 90 %. At acetate volume loads below 1600 mg C/(m³.h) the AOC concentration in the filtrate was less than 0.01 mg of ac-C eq/l, the AOC criterium for biologically-stable drinking water. The AOC concentration in the filtrate of filters from water treatment plants in the Netherlands was less than 0.01 mg at AOC volume loads of less than 100 mg C/(m³.h). This means that acetate was removed more efficiently in biological filters than an equivalent amount of assimilable organic compounds in the water measured with the AOC determination.

- The highest number of bacteria in the sand of a biological filter was found in the top layer (< 1 cm) of the filter bed. Addition of acetate in a concentration as low as 0.01 mg C/l increased these numbers significantly. The heterotrophic colony count in the first centimeter of the filter bed was linearly related to the acetate concentration in the influent.

- Bacterial matter accumulated in the filter bed, event at AOC concentrations as low as 0.005 mg ac-C/l. The advised AOC concentration for water used for infiltration purposes was 0.01 mg ac-C eq/l and similar to the concentration for biologically-stable drinking water (VAN DER KOOIJ and HIJNEN, 1990).

- The heterotrophic colony counts in the filtrate increased linearly with the acetate volume load (mg ac-C/(m³.h)). The AOC volume load of the final filtration process in water treatment should be limited to prevent the use of post disinfection for reducing the heterotrophic colony count of the final product.

ACKNOWLEDGEMENTS

This investigation was part of the research program of KIWA Ltd., assigned and financed by the Netherlands Waterworks Association (VEWIN). We thank J. Bakker and C. Koning for performing AOC determinations and A.F. Van Dam and H.W. Van der Klift for their technical assistance with the filtration experiments.

REFERENCES

- BÖCKLE R., ROHMAN U., SONTHEIMER H., 1984. Denitrifikation in biologisch arbeitenden Aktivkohlefiltern. *Neue Technologien in der Trinkwasserversorgung DVGW-Schriftenreihe Wasser 105*, 153-178.
- GUPTA R.P., SWARTZENDRUBER D., 1962. Flow associated reduction in the hydraulic conductivity of quartz sand. *Soil Sci. Soc. Am. Pro. 26*, 5-10.
- HIJNEN W.A.M., KONING D., KRUIJTHOF J.C., VAN DER KOOIJ D., 1988. The effect of bacteriological nitrate removal on the concentration of bacterial biomass and easily assimilable organic carbon compounds in groundwater. *Wat. Supply 6*, 265-273.
- HIJNEN W.A.M., VAN DER KOOIJ D., 1992. The effect of low concentrations of assimilable organic carbon (AOC) in water on biological clogging of sand beds. *Water Research 26*, 963-972.
- JORET J.C., LEVI Y., 1986. Méthode rapide d'évaluation du carbone éliminable des eaux par voie biologique. *Tribune du Cedebeau 39*, 3-9.
- KAWANISHI T., KAWASHIMA H., CHIHARA K., SUZUKI M., 1990. Effect of biological clogging on infiltration rate in soil treatment systems. *Wat. Sci. Tech. 22*, 101-108.
- PETERS J.H., 1985. State of the art of borehole recharge in Holland. *Wat. Supply 3*, 51-58.
- PHILIPOT J.M., 1982. Traitement biologique des eaux usées urbaines et potables : l'intérêt de la fixation des bactéries sur support. *Aqua 5*, 28-30.
- RICHARD Y., LEPRINCE A., 1980. L'azote dans le traitement des eaux potables : les traitements biologiques. *TSM-L'eau 4*, 167-181.
- ROENNEFAHRT K.W., 1986. Nitratenfernung bei der Trinkwasseraufbereitung mittels Heterotroph aquatischer Mikroorganismen in Festbettreaktoren. *Neue Technologien in Trinkwasserversorgung DVGW-Schriftenreihe 106*, 169-179.
- SCHIPPERS J.C., VERDOUW J., 1984. Development and application of the membrane-filtration-index and the parallel-filtration-index. *KIWA communication 79*, in Dutch.
- SERVAIS P., BILLEN G., HASCOET M.C., 1987. Determination of the biodegradable fraction of dissolved organic matter in waters. *Water Research 21*, 445-450.
- SERVAIS P., BILLEN G., VENTRESQUE CL., BABLON G.P., 1991. Microbiological activity in GAC filters at the Choisy-le-Roi treatment plant. *J. AM. Water Works Assoc. 83 (2)*, 62-68.
- SHAW J.C., BRAMHILL B., WARDLAW N.C., COSTERSON J.W., 1985. Bacterial Fouling in a Model Core System. *Appl. Environ. Microbiol. 49*, 693-701.
- STANFIELD G., JAGO P.H., 1987. The development and use of a method for measuring the concentration of assimilable organic carbon in water. Report PRU 1628-M, Water Research Centre, U.K.

- VAN DER KOOIJ D., VISSER A., HIJNEN W.A.M., 1982. Determining the concentration of easily assimilable organic carbon in drinking water. *J. Am. Water Works Assoc.* 74, 540-545.
- VAN DER KOOIJ D., 1984. The growth of bacteria on organic compounds in drinking water. *Thesis*, Rijswijk, 1984.
- VAN DER KOOIJ D., HIJNEN W.A.M., KRUIHOF J.C., 1987. The effects of ozonation, biological filtration and distribution on the concentration of easily assimilable organic carbon (AOC) in drinking water, pp. D96-D113 in Proceedings 8th Ozone World Congress, International Ozone Association, Switzerland.
- VAN DER KOOIJ D., HIJNEN W.A.M., 1990. Criteria for defining the biological stability of drinking water as determined with AOC measurements. *AWWA Water Quality Technology Conf. San Diego*, November 11-15, California, 1281-1298.
- WERNER P., 1985. Eine methode zur Bestimmung der Verkeimungsneigung von Trinkwasser. *Vom Wasser* 65, 257-270.